

Sensors and Controls

# sceneCOM S

## Manual

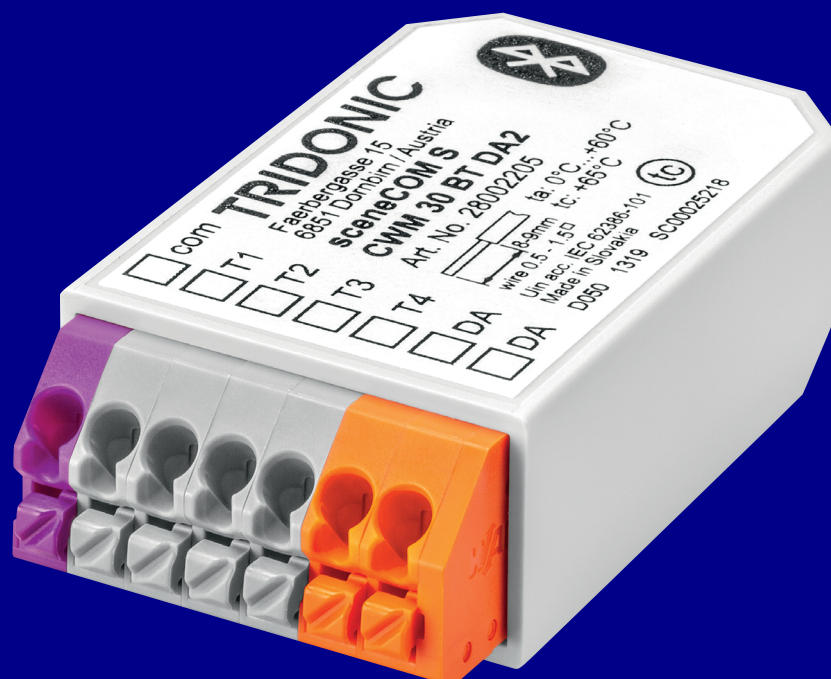

# TRIDONIC

# Table of Contents

<b>1. Validity</b>	<b>3</b>
1.1. Copyright	3
1.2. Imprint	3
<b>2. Safety instructions</b>	<b>4</b>
2.1. Intended use	4
2.2. Dangers associated with the operation of the system	4
<b>3. The sceneCOM S system</b>	<b>6</b>
3.1. General information	6
3.2. System components	6
3.3. sceneCOM S solution schematic	9
3.4. Connection diagram	9
3.5. Wiring type	9
3.6. Wireless signal range	11
3.7. Placement and mounting of sceneCOM S	11
<b>4. Applications overview</b>	<b>12</b>
4.1. Individual office (cabinet type)	13
4.2. Open plan office	15
4.3. Meeting / conference room	17
4.4. Classroom	19
4.5. Warehouse / DIY shop (between shelf lighting control)	21
4.6. Industrial midrack small area applications	23

## Scope of documentation

This operating instruction is valid for the sceneCOM S system.

TRIDONIC GmbH & Co KG is constantly striving to develop all its products. This means that there may be changes in form, equipment and technology.

Claims cannot therefore be made on the basis of information, diagrams or descriptions in these instructions.

The latest version of these operating instructions is available on our home page at <http://www.tridonic.com/com/en/operating-instructions.asp>

### 1.1. Copyright

This documentation may not be changed, expanded, copied or passed to third parties without the prior written agreement of TRIDONIC GmbH & Co KG.

We are always open to comments, corrections and requests. Please send them to [info@tridonic.com](mailto:info@tridonic.com)

### 1.2. Imprint

Tridonic GmbH & Co KG  
Färbergasse 15  
6851 Dornbirn  
Austria  
T +43 5572 395-0  
F +43 5572 20176  
[www.tridonic.com](http://www.tridonic.com)

# Safety instructions

The instructions in this section have been compiled to ensure that operators and users of the sceneCOM S system from Tridonic are able to detect potential risks in good time and take the necessary preventative measures.

The operator must ensure that all users fully understand these instructions and adhere to them. This device may only be installed and configured by suitably qualified personnel.

## 2.1. Intended use

### 2.1.1. Proper use

DALI-2 monitoring and control solution. DALI-2 devices can be configured locally via Bluetooth connection and app. The device may only be used for this intended purpose.

### 2.1.2. Improper use

Outdoor use. Extensions and modifications to the product.

#### WARNING!

Improper use could result in injury, malfunction or damage to property.  
It must be ensured that the operator informs every user of existing hazards.

## 2.2. Dangers associated with the operation of the system

#### DANGER!

Danger of electrocution  
Disconnect the power to the entire lighting system before working on the lighting system!

#### CAUTION!

Risk of damage caused by condensation  
Prior to commissioning the system, wait until the control device is at room temperature and completely dry!

#### CAUTION!

Risk of damage caused by humidity  
Only use the control device in dry rooms and protect it against humidity!

## Safety instructions

### CAUTION!

#### Electromagnetic compatibility (EMC)

Although the Tridonic control device meets the stringent requirements of the appropriate directives and standards on electromagnetic compatibility, it could potentially interfere with other devices under certain circumstances!



## The sceneCOM S system

### 3.1. General information

The sceneCOM S system is a DALI-2 monitoring and control solution. DALI-2 devices can be configured locally via Bluetooth connection and app.



The sceneCOM S can be updated over the air, providing a continuously evolving solution.

### 3.2. System components

Image	Title	Description
	sceneCOM S	<p>DALI Application Controller</p> <ul style="list-style-type: none"> <li>_ Supporting the full Tridonic DALI-2 Portfolio and other DALI-2 certified devices</li> <li>_ Future-proof thanks to simple firmware update via Bluetooth App</li> <li>_ 4 independent inputs enabling connection of floating contact, standard momentary switches</li> <li>_ Power supply via DALI line</li> </ul>
	MSensor G3 SFI 30 PIR 5DPI WH/BK	<ul style="list-style-type: none"> <li>_ Sensor developed to work with the latest DALI specification</li> <li>_ Monitoring of ambient light and motion detection</li> <li>_ Remote control interface allowing infrared remote control interaction</li> <li>_ Individual adjustment of the parameters with configuration software</li> <li>_ Power supply via DALI line</li> <li>_ Shutter for preventing movement detection in one direction included</li> <li>_ Small dimensions allowing easy and inconspicuous integration in luminaries</li> <li>_ Wide range of accessories allowing extended application range</li> </ul>



...proceed on next page

## The sceneCOM S system

Image	Title	Description
	MSensor G3 SFI 30 PIR 10DPI WH	<ul style="list-style-type: none"> <li>_ Sensor developed to work with the latest DALI specification</li> <li>_ Monitoring of ambient light and motion detection</li> <li>_ Remote control interface allowing infrared remote control interaction</li> <li>_ Individual adjustment of the parameters with configuration software</li> <li>_ Power supply via DALI line</li> <li>_ Shutter for preventing movement detection in one direction included</li> <li>_ Small dimensions allowing easy and inconspicuous integration in luminaries</li> <li>_ Wide range of accessories allowing extended application range</li> </ul>
	MSensor G3 SFI 30 PIR 16DPI WH	<ul style="list-style-type: none"> <li>_ Sensor developed to work with the latest DALI specification</li> <li>_ Monitoring of ambient light and motion detection</li> <li>_ Remote control interface allowing infrared remote control interaction</li> <li>_ Individual adjustment of the parameters</li> <li>_ Power supply via DALI line</li> <li>_ Mounting ring and gasket included to reach IP65 protection</li> <li>_ Wide range of accessories allowing extended application range</li> <li>_ Double terminals for through wiring</li> </ul>
	REMOTECONTROL IR6	<ul style="list-style-type: none"> <li>_ Optional infra-red remote control</li> <li>_ Switching on and off (On/Off button)</li> <li>_ Dimming (Up/Down button)</li> <li>_ Activation of automatic lighting control (Automatic button)</li> <li>_ Setting the threshold control point (Set button)</li> </ul> <p>The REMOTECONTROL IR6 has a separate documentation:  <a href="https://www.tridonic.com/en/download/technical/REMOTECONTROL_IR6_en.pdf">https://www.tridonic.com/en/download/technical/REMOTECONTROL_IR6_en.pdf</a></p>

...proceed on next page

## The sceneCOM S system

Image	Title	Description
	DALI-PCD 1-300 one4all G2	<ul style="list-style-type: none"> <li>_ Digital leading-edge and trailing-edge phase dimmer</li> <li>_ Total connected load: 1 – 300 VA</li> <li>_ one4all input: DALI, DSI, switchDIM and corridorFUNCTION input</li> <li>_ Zero cross switching supported</li> <li>_ 1 dimmed phase (output)</li> <li>_ With automatic load detection</li> <li>_ Surface-mounted casing</li> <li>_ Suitable for operation with LED retrofit bulbs</li> </ul>
	LED Drivers	<p><b>All Tridonic Drivers with one4all interface are supported</b></p> <ul style="list-style-type: none"> <li>_ Best dimming quality from 1 – 100 %</li> <li>_ High efficiency of up to 92 %</li> <li>_ Large number of designs including the new Stretched Compact housing with attachable cable clamp</li> </ul>
	DALI PS3	<ul style="list-style-type: none"> <li>_ DALI-2 power supply providing 70 mA for a DALI-2 installation</li> <li>_ Excellent scalability allowing to connect up to 2 PS3 in a DALI-2 installation</li> <li>_ Compact form factor combined with detachable mounting flaps allowing high installation flexibility, e.g. in luminaire</li> <li>_ Up to 100,000 guaranteed operating hours enable outstanding life-time of the entire lighting system</li> </ul>



## The sceneCOM S system

### 3.3. sceneCOM S solution schematic

sceneCOM S supports:

- \_ single DALI Line (max 250mA):
- \_ up to 64 converters / drivers
- \_ 16 groups
- \_ 16 scenes
- \_ 16 input devices / sensors / push buttons

### 3.4. Connection diagram

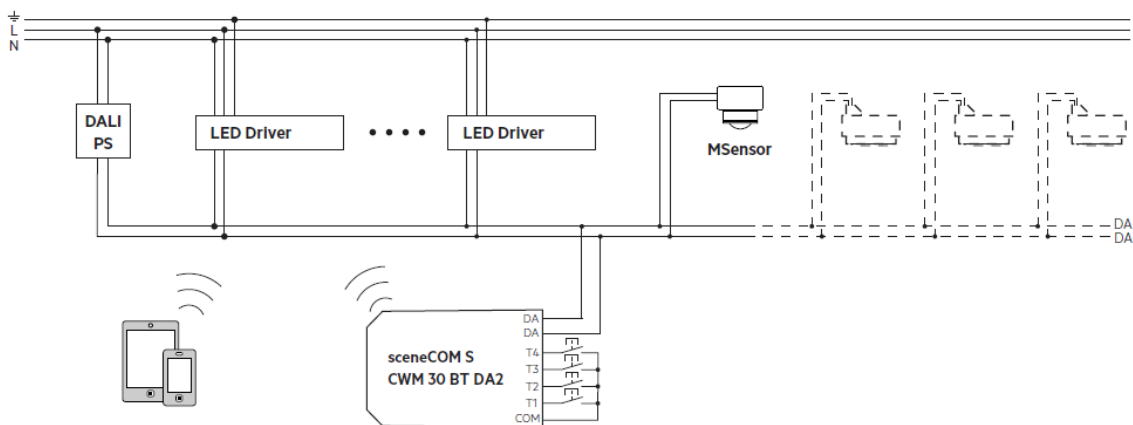

### 3.5. Wiring type

Wire length and cross section

In DALI the wire length is limited depending on the cross section and material used. Try to avoid wire length above 300 m in your DALI installation.

## The sceneCOM S system

Max. output cable length

Recommended wire length depending on material, ambient temperature and cross section.

Material	Cross section	Max. cable length		
		25 °C	50 °C	75 °C
Copper	0.20 mm <sup>2</sup>	45 m	41 m	37 m
	0.50 mm <sup>2</sup>	112 m	102 m	93 m
	0.75 mm <sup>2</sup>	168 m	153 m	140 m
	1.00 mm <sup>2</sup>	224 m	204 m	187 m
	1.50 mm <sup>2</sup>	300 m <sup>(1)</sup>	300 m <sup>(1)</sup>	281 m
Aluminum	0.20 mm <sup>2</sup>	27 m	25 m	23 m
	0.50 mm <sup>2</sup>	68 m	62 m	57 m
	0.75 mm <sup>2</sup>	102 m	93 m	86 m
	1.00 mm <sup>2</sup>	136 m	125 m	115 m
	1.50 mm <sup>2</sup>	205 m	187 m	172 m

<sup>(1)</sup> Cable lengths of more than 300 m are not recommended.

## The sceneCOM S system

### 3.6. Wireless signal range

Maximum range of the signal provided by the sceneCOM S is up to 20 m. Avoid mounting the device behind glass, concrete surfaces and in metal enclosures. If mounted behind such materials the signal range will be reduced.

Wireless signals are electromagnetic waves. These waves are damped under the following circumstances:

- \_ Increasing distance between sceneCOM S and your smart device
- \_ Materials of different compositions near the sceneCOM S and your smart device
- \_ Building installations, such as hollow drywall with insulation wool on metal foil, suspended ceilings with metal or carbon fibre panels, fixtures and furnishings made of steel, glass, lead glass or with metal coating, and metal walls/surfaces
- \_ Fire protection walls, lift shafts, stairwells and supply areas must be considered completely sealed areas

### 3.7. Placement and mounting of sceneCOM S

The sceneCOM S DALI-2 application controller has an integrated antenna. Certain materials can reduce the range of the antenna. During installation, the following should be observed. The antenna is located at the corner of the case, at the bottom of the PCB, just above the bottom of the device. By placing the antenna at this point, the influence of other components on the antenna performance is minimized. In addition, the device should be placed as far away as possible from metal structures. Wires of the device should not lead past the antenna.

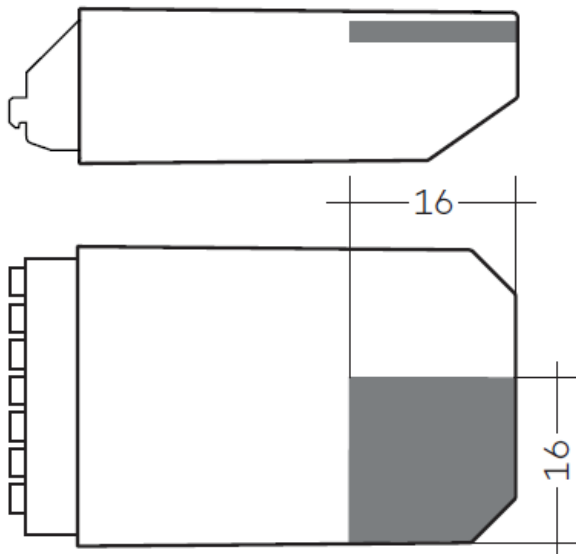

The antenna location is the grey area on the graph.

## Applications overview

The sceneCOM S System can cover all applications where one DALI-2 Line fulfills the requirement.

In the following pages a short overview of different applications is described.

- \_ Individual office (cabinet type), p. 13
- \_ Open plan office, p. 15
- \_ Meeting / conference room, p. 17
- \_ Classroom, p. 19
- \_ Warehouse / DIY shop (between shelf lighting control), p. 21
- \_ Industrial midrack small area applications, p. 23

## Applications overview

### 4.1. Individual office (cabinet type)

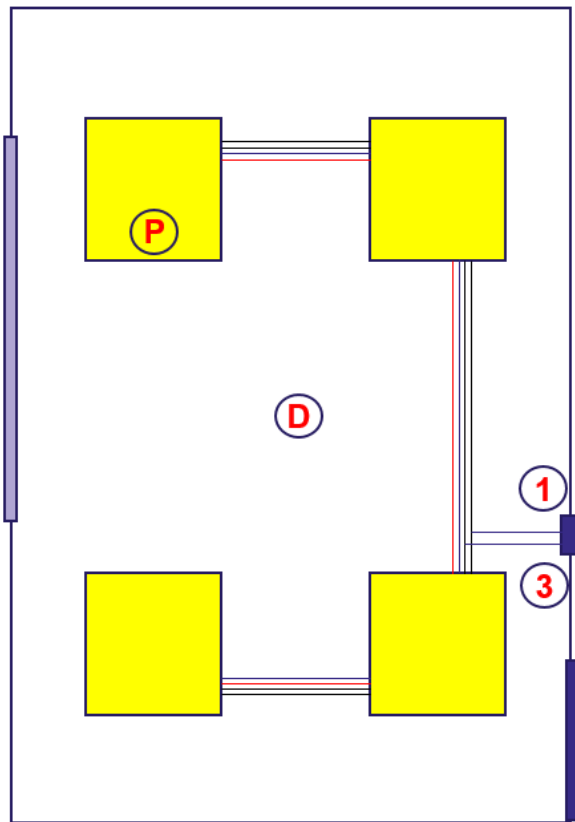

#### Basic setup:

- \_ On/Off,
- \_ Dim Up/Down,
- \_ Daylight/Presence control,
- \_ Push-button (manual-input)

#### Advanced setup:

- \_ IR6 remote
- \_ On/Off,
- \_ Dim Up/Down
- \_ Daylight/Presence
- \_ Push-button (manual-input)
- \_ Direct-Indirectlight control
- \_ Only-off function,
- \_ Basic Tunable White
- \_ Grouping
- \_ Scenes

## Applications overview

Tridonic controls used:



sceneCOM S

1



MSensor G3  
Lowbay

**M** - Multi- sensor  
(presence & light)

**P** - Presence sensor  
(presence only)



DALI PS3

3



IR6  
remote

4

## Open plan office

### 4.2. Open plan office

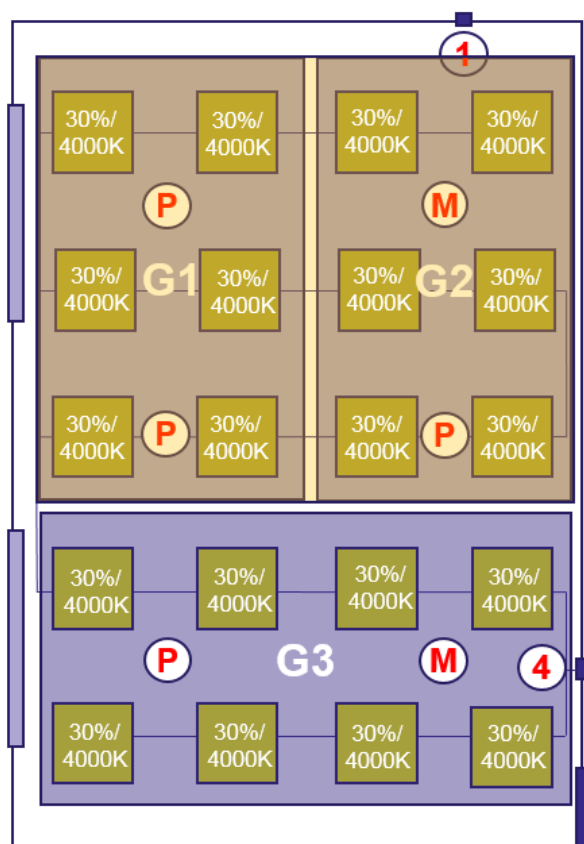

#### Basic setup:

- \_ On/Off,
- \_ Dim Up/Down,
- \_ Daylight/Presence control,
- \_ Push-button (manual-input)
- \_ Grouping\*

#### Advanced setup:

- \_ On/Off,
- \_ Dim Up/Down
- \_ Daylight/Presence
- \_ Push-button (manual-input)
- \_ Direct-Indirectlight control
- \_ Only-off function,
- \_ Basic Tunable White
- \_ Grouping\*
- \_ Scenes\*\*

\*-Single sensor can be applied to multiple groups

\*\* -Single switch can be applied to multiple groups

## Open plan office

Tridonic controls used:



sceneCOM S

**1** - Multi-master application controller



MSensor G3 Lowbay

**M** - Multi-sensor (presence & light)

**P** - Presence sensor (presence only)



DALI PS3

**3** - DALI Power supply



DALI XC G3

**4** - DALI Push button input



IR6 remote

**5** - IR remote



## Meeting / conference room

### 4.3. Meeting / conference room

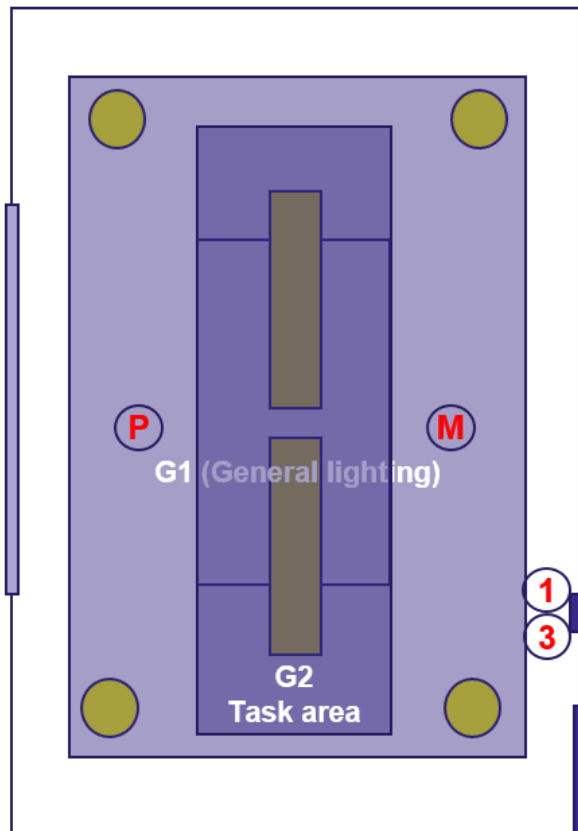

#### Basic setup:

- \_ On/Off,
- \_ Dim Up/Down,
- \_ Daylight/Presence control,
- \_ Push-button (manual-input)
- \_ Grouping\*

#### Advanced setup:

- \_ On/Off,
- \_ Dim Up/Down
- \_ Daylight/Presence
- \_ Push-button (manual-input)
- \_ Direct-Indirectlight control
- \_ Only-off function,
- \_ Basic Tunable White
- \_ Grouping\*
- \_ Scenes\*

\*-Single sensor can be applied to multiple groups

## Meeting / conference room

Tridonic controls used:



sceneCOM S

**1** - Multi-master application controller



MSensor G3  
Lowbay

**M** - Multi- sensor (presence & light)

**P** - Presence sensor (presence only)



DALI PS3

**3** - DALI Power supply



IR6 remote

**4** - IR remote

## Meeting / conference room

### 4.4. Classroom

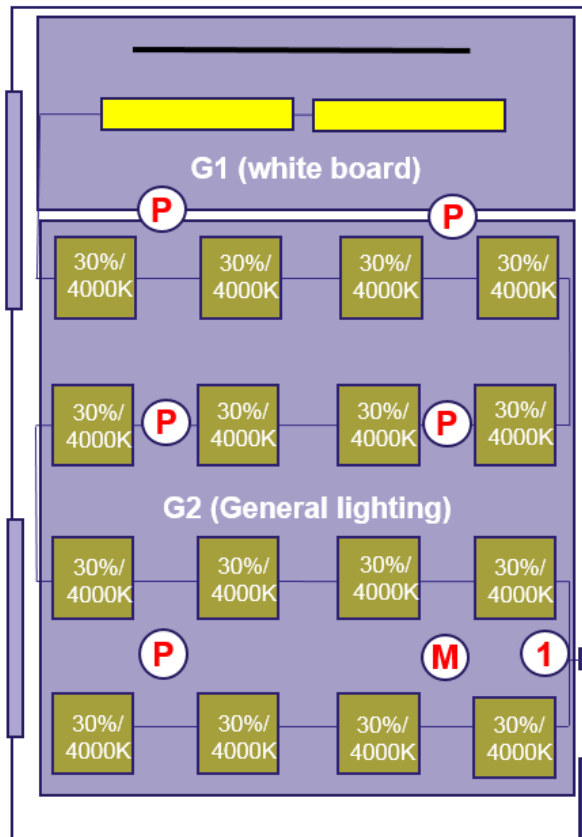

Basic setup:

- \_ On/Off,
- \_ Dim Up/Down,
- \_ Daylight/Presence control,
- \_ Push-button (manual-input)
- \_ Grouping\*

Advanced setup:

- \_ On/Off,
- \_ Dim Up/Down
- \_ Daylight/Presence
- \_ Push-button (manual-input)
- \_ Only-off function,
- \_ Basic Tunable White
- \_ Grouping\*
- \_ Scenes\*\*

\*-Single sensor can be applied to multiple groups

\*\* -Single switch can be applied to multiple groups

## Meeting / conference room

Tridonic controls used:



sceneCOM S

**1** - Multi-master application controller



MSensor G3  
Lowbay

**M** - Multi- sensor (presence & light)

**P** - Presence sensor (presence only)



DALI PS3

**3** - DALI Power supply



IR6 remote

**4** - IR remote

## Warehouse / DIY shop

### 4.5. Warehouse / DIY shop (between shelf lighting control)

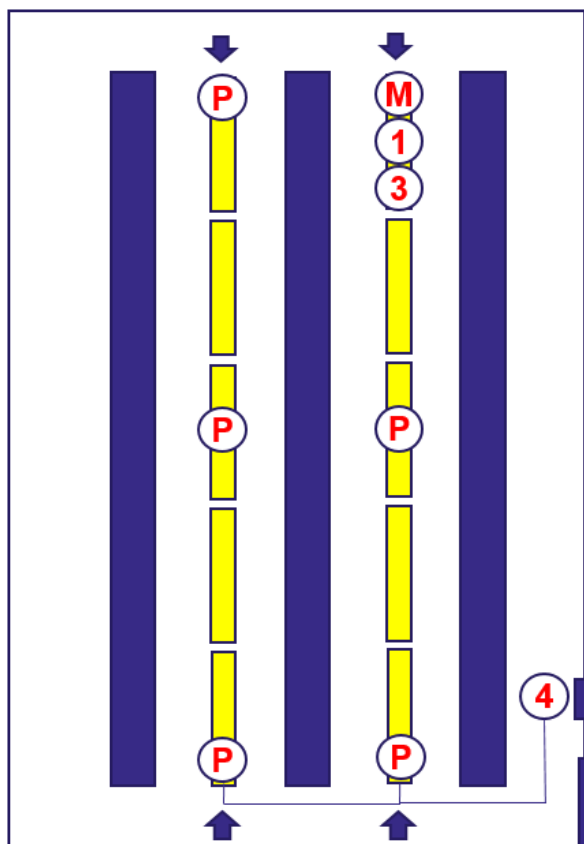

Basic broadcast setup:

- \_ On/Off,
- \_ Dim Up/Down,
- \_ Mainly presence control, light sensing also possible
- \_ Push-button (manual-input)
- \_ Broadcast
- \_ Only-off function

Focus use-case:

Continues presence detection until peoples or mashines staying between shelves, racks or production lines, light sensing with the master-sensor.

Reasonable emergy savings around 45 %.

This use-case as well can be relevant for dot-type light sources (e.g. midbay/highbay fixtures)

Tridonic controls used:

## Warehouse / DIY shop



MSensor G3  
Lowbay

DALI PS3

DALI XC G3

IR6 remote

1

- Multi-master  
application  
controller

M

- Master sensor  
(presence & light)

P

- Presence sensor  
(presence only)

3

- DALI  
Power  
supply

4

- DALI  
Push  
button  
input

5

- IR  
remote

## Industrial midrack small area applications

### 4.6. Industrial midrack small area applications

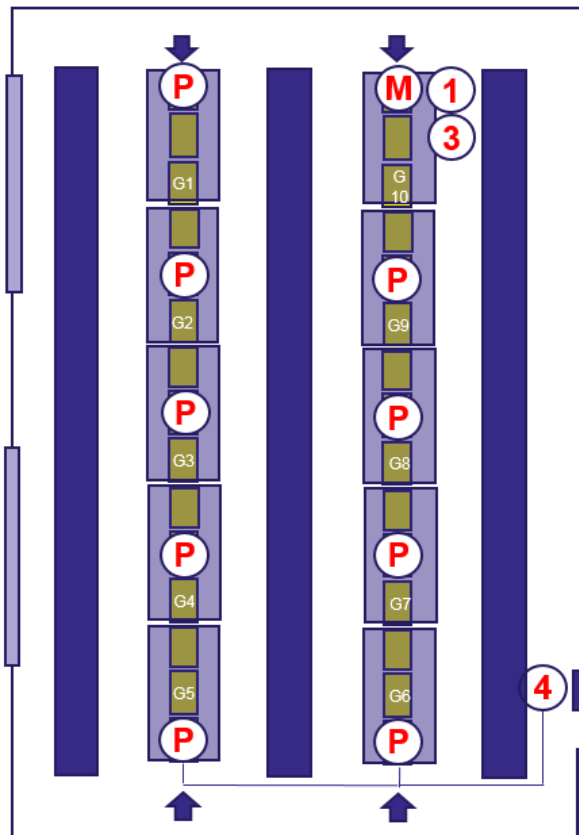

Advanced setup:

- \_ On/Off,
- \_ Dim Up/Down,
- \_ Mainly presence control,
- \_ Push-button (manual-input)
- \_ Grouping\*
- \_ TunableWhite

\*-Single sensor can be applied to multiple groups

Focus use-case:

Areas not continuously occupied with people and machines, light follow you, Maximal energy savings 80-90 %.  
This use-case as well can be relevant for dot-type light sources (e.g. midbay/highbay fixtures)